

## Assembly instructions - 7ft -

### Tools Needed:

- Hammer
- Pneumatic brad nailer (preferred)
- Power drill
- Level
- Power miter saw (preferred)
- $\frac{3}{32}$ " pilot drill
- Nail set
- Wood filler (optional)
- 180 grit sand paper (optional)

### Fasteners:

- 1  $\frac{1}{4}$ " finishing nails to fasten cross pieces
- 1  $\frac{1}{4}$ " brad nails if using pneumatic brad nailer
- #8x1  $\frac{1}{4}$ " screws to attach to other modules
- #8x3" screws for attaching racks to wall

### Tips:

1. Using pneumatic brad nailer will make assembly quicker and easier.
2. Before opening any boxes, if multiple units and different units have been ordered, please assemble all boxes by units to ensure that specific unit parts are not intermixed with other units.
3. It is highly recommended to drill  $\frac{3}{32}$ " dia pilot holes on back cross pieces for #8x3" screws before attaching to wall.

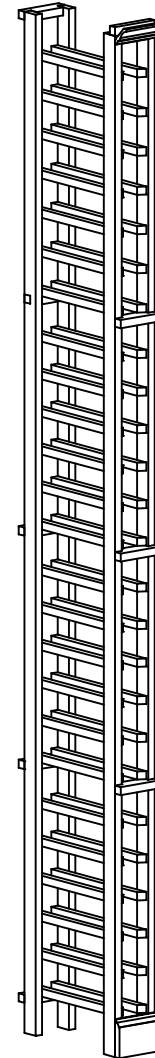

# Part list:

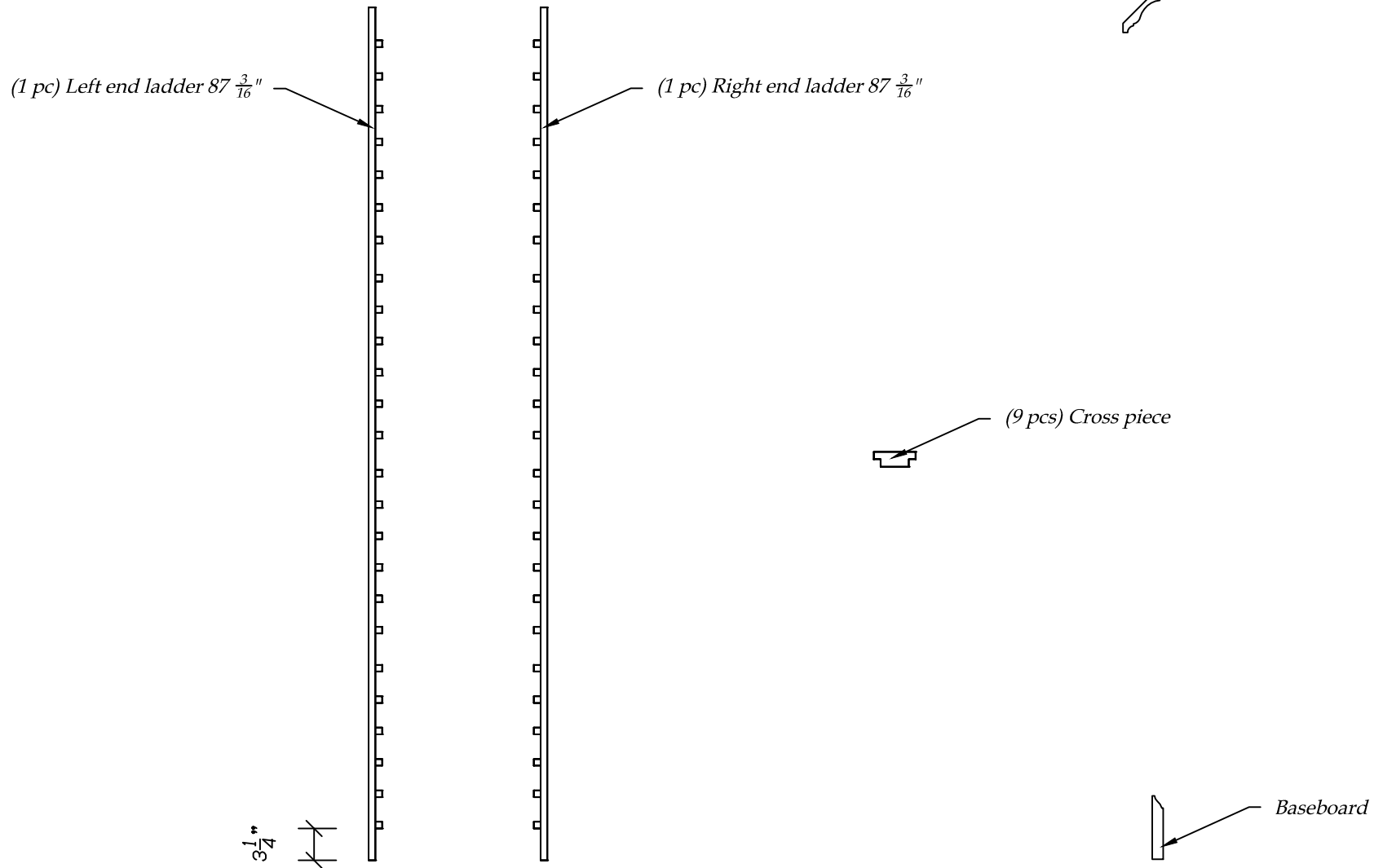

## Step 1

Attaching cross pieces to the **BACK**.

Place the right and left end ladders on the floor making sure the angled cleats are facing floor. Nail the cross pieces under the 1st, 7th, 13th and 19th cleat starting from the bottom. Nail the top cross piece flash with top of the ladders.

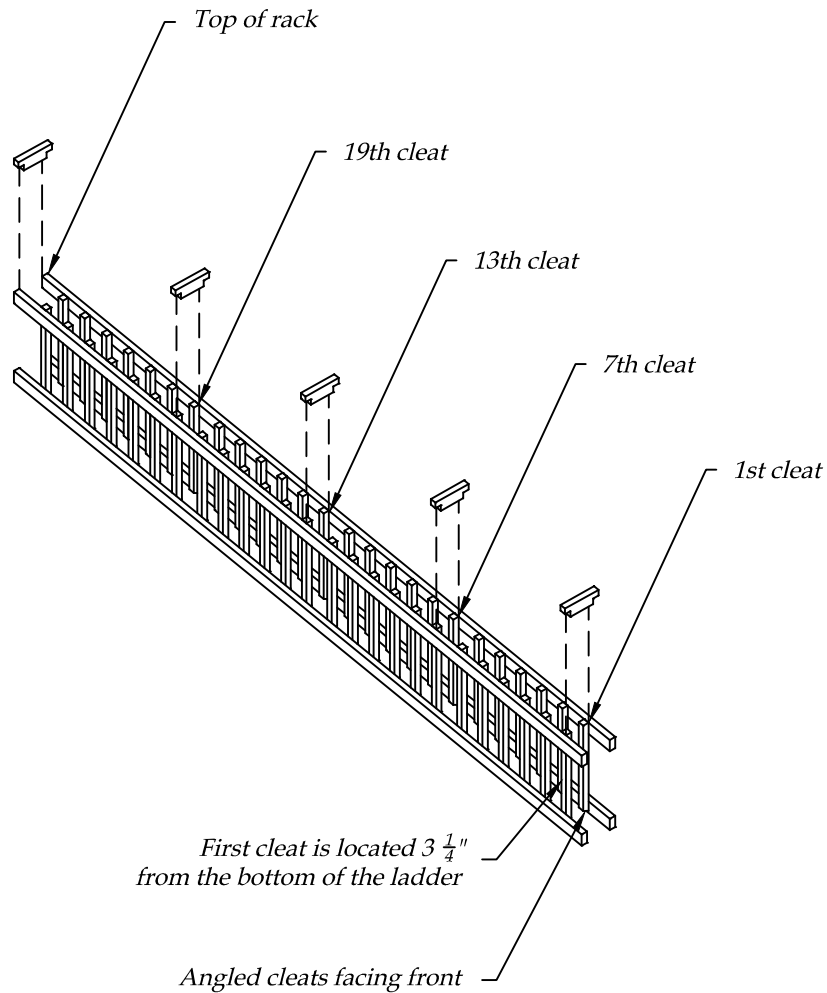

## Step 2

Attaching **FRONT** cross pieces.

Nail the cross pieces under the 7th, 13th and 19th cleat starting from the bottom. Nail the top cross piece flash with front of the ladders as shown.

