

CEILING MOUNT TWIN
OWNER'S MANUAL

*Whisper***KOOL**[™]
The Coolest Thing In Wine Storage

Conforms to ANSI/UL Std 427

Certified to CAN/CSA Std C22.2 No. 120

We manufacture, test and certify 100% of our wine cooling units in the USA. By sourcing the best components and closely controlling our manufacturing processes, we can assure the highest-quality, lowest defect manufacturing rates in the industry.

Copyright © 2017. WhisperKOOL. All rights reserved.

WhisperKOOL copyrights this manual, the product design, and the design concepts, with all rights reserved. Your rights with regard to the hardware and manual are subject to the restrictions and limitations imposed by the copyright laws of the USA. Under copyright laws, this manual may not be copied, reproduced, translated, transmitted, or reduced to any printed or electronic medium or to any machine-readable form, for any purpose, in whole or in part, without the written consent of WhisperKOOL.

Every effort has been made to ensure that the information in this manual is accurate. WhisperKOOL is not responsible for printing or clerical errors.

WhisperKOOL reserves the right to make corrections or improvements to the information provided and to the related hardware at any time, without notice.

Vinothèque and WhisperKOOL are registered trademarks, and ECE is a trademark of WhisperKOOL. All rights reserved.

Mention of third-party products is for informational purposes only and constitutes neither an endorsement nor a recommendation. WhisperKOOL assumes no liability with regard to the performance or use of these products.

TABLE OF CONTENTS

Introduction	3
Before You Start	4
Receiving & Inspecting the System	5
Quick Reference Guide	
Knockout Locations.....	7
Display Layout & Unit Specifications.....	8
Condensing Unit	10
Preparing the Wine Cellar	11
Liquid-Measuring Thermostat (Bottle Probe)	14
System Operation	15
Controller Functions	17
Troubleshooting Guide	22
Maintenance Schedule	24
Technical Assistance & Accessories	25
Installation Terms and Conditions	26



WARNING



The evaporator unit (fan coil unit) must be insulated using the insulation blanket provided in accordance with this manual. Refer to the insulation blanket installation instructions.

Failure to follow the instructions provided will result in a poor vapor barrier, water damage, rust, and system corrosion which will void the warranty on your unit.

The evaporator unit (fan coil unit) must be insulated using fiberglass insulation (R19 or higher) in addition to the provided insulation blanket. This includes the cavity between the ceiling joists. A warm attic environment will reduce the capacity of the cooling system, as the system will absorb heat from the attic in addition to the heat load from the wine cellar. This, in effect, will significantly reduce the cooling system's ability to cool the wine cellar.

Failure to properly insulate the evaporator unit may cause condensation to form on the surface of the housing and water damage to the surrounding structure, the cooling unit, and possibly the wine cellar.

To avoid these issues, install the insulation kit and insulate the surface of the evaporator unit that is located outside of the wine cellar using fiberglass insulation.

***Additional insulation is required!**

INTRODUCTION

Customer Service

Thank you for purchasing a WhisperKOOL cooling system. We strive to provide the highest-quality products and the best possible customer service. If you have any questions about your system, please call us at 1-800-343-9463.

Using the Manual

This manual is intended to assist in the proper maintenance of the cooling system. In order to ensure the longevity of your cooling unit, the equipment should be installed as outlined in the technician's manual. It is also vital to establish a proper care and maintenance schedule. Please read and review this manual carefully and keep it for future reference.

What is the WhisperKOOL Cooling System?

The WhisperKOOL cooling system is a specialized refrigeration system designed for one purpose only: to maintain the optimal temperature and humidity levels conducive to the proper storage and aging of fine wines. This system produces minimal in-cellar noise and has the most lenient exhaust requirements. An exterior housing is required for outdoor condensing unit installations.

How Does the Cooling System Work?

Similar to the air conditioning systems used for homes, the evaporator unit and condensing units are installed in separate locations and are connected by a refrigerant line set. The evaporator portion is commonly installed in the wine cellar, with the condensing unit is located either outside or in a remote indoor location that is ventilated. An exterior housing is required for outdoor condensing unit installations.

Temperature Setting

The system is designed to maintain a cellar temperature of 55°F as long as the ambient temperature does not exceed 110°F.

WARRANTY REGISTRATION

In order to activate the warranty of your system, the verification and operational documentation must be completed by the certified refrigeration technician installing your system and submitted via mail, fax, or e-mail.

Mail to:
WhisperKOOL
ATTN: Warranty Registration
1738 E. Alpine Avenue
Stockton, CA 95205-2505
USA

Fax to:
209-466-4606

1. **Inspect all components prior to installation.** If damage is found, please contact your distributor or WhisperKOOL Customer Service at 1-800-343-9463.
2. The evaporator units and condensing unit **each require a dedicated 115V, 20-amp circuit.** Use a surge protector with the system. **Do not use a GFI** (ground fault interrupter) line.
3. You are **REQUIRED** to **install a drain line** to remove condensation from the evaporator units.
4. ***The warranty is not active until a warranty checklist has been received, reviewed, and approved.***
5. The system is intended **for use in properly designed and constructed wine cellars.** Hire a professional wine storage consultant with a valid contractor's license to build your wine cellar.
6. WhisperKOOL requires that all split systems be installed by a certified HVAC-R technician only. NATE or equivalent is recommended.
7. ***It is vital that the units be set apart and oriented so that the return air from one unit does not recirculate into the supply air of the other unit.***

If you encounter a problem with your WhisperKOOL system, please refer to the Troubleshooting Guide. If you have any further questions or concerns, or need assistance, please contact WhisperKOOL's Customer Service at 1-800-343-9463. Please be sure all testing has been completed prior to contacting Customer Service. Please have your results ready for your representative.

RECEIVING & INSPECTING THE SYSTEM

- Use caution when lifting and check package for damage.
- Lift only at the designated hand-hold locations on the shipping container, or fully support the container from underneath. A shipment may include one or more boxes containing accessories.
- Before opening the container, inspect the packaging for any obvious signs of damage or mishandling.
- Write any discrepancy or visual damage on the bill of lading before signing.
- Allow the condensing unit to sit for 24 hours prior to startup. The condensing unit can be placed in the installation location, piped and evacuated during this time.

Note: WhisperKOOL units are manufactured in the USA and tested prior to shipment.

- Review the packing slip to verify contents.
- Check the model number to ensure it is correct.
- Check that all factory options ordered are listed.

If any items listed on the packing slip do not match your order information, contact WhisperKOOL Customer Service immediately.

Check all shipped boxes for the following contents:

Evaporator Unit Box 1

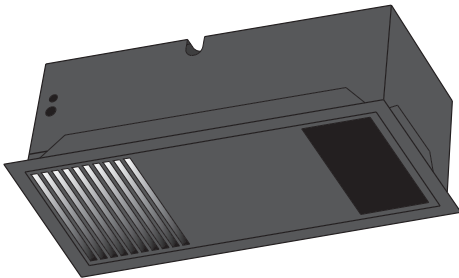

(1) Master evaporator unit

Evaporator Unit Box 2

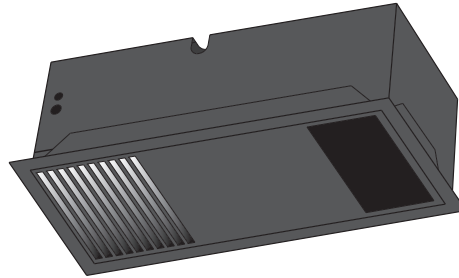

(1) Slave evaporator unit

Condensing Unit Box

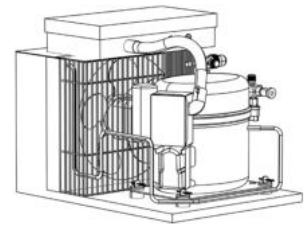

(1) Ceiling Mount condensing unit

Documentation bag (master):

- Ceiling Mount Twin owner's manual
- Ceiling Mount Twin technician's manual
- R-404a split system warranty checklist

Accessory kit bag (master):

- Stainless steel probe (50 feet)
- KDT Plus display cable (50 feet)
- KDT Plus wall mount bracket assembly
- KDT Plus flush mount bracket assembly
- KDT Plus display assembly
- Flush mount template
- Evaporator installation hardware bag
- KDT Plus hardware bag

Insulation blanket bag (master):

- (1) Ceiling Mount insulation blanket

Evaporator installation hardware bag (slave)

Insulation blanket bag (slave):

- (1) Ceiling Mount insulation blanket

Evaporator installation hardware bag (master):

- (12) 2½" Phillips wood screws
- (12) #8 ⅜" Phillips pan-head screws
- (1) Bypass plug
- (1) ¼" barbed coupling
- (2) 3" strips of cork tape

KDT Plus hardware bag:

- (1) ⅛" OD grommet
- (2) ½" nylon hole plugs
- (4) #6 x 1" Phillips zinc Type A screws
- (4) 8-10 x ⅞" blue plastic screw anchors

Evaporator installation hardware bag (slave):

- (12) 2½" Phillips wood screws
- (12) #8 ⅜" Phillips pan-head screws
- (1) Bypass plug
- (1) ¼" barbed coupling
- (2) 3" strips of cork tape

Condensing unit accessory kit:

- (1) Filter drier
- (1) Sight glass

Please leave the system in its original box until you are ready for installation. This will allow you to move the product safely without damaging it. When you are ready to remove the product from the box, refer to the installation instructions.

TIP: Save your box and all packaging materials. They provide the only safe means of transporting/shipping the system.

QUICK REFERENCE GUIDE

Bottom View

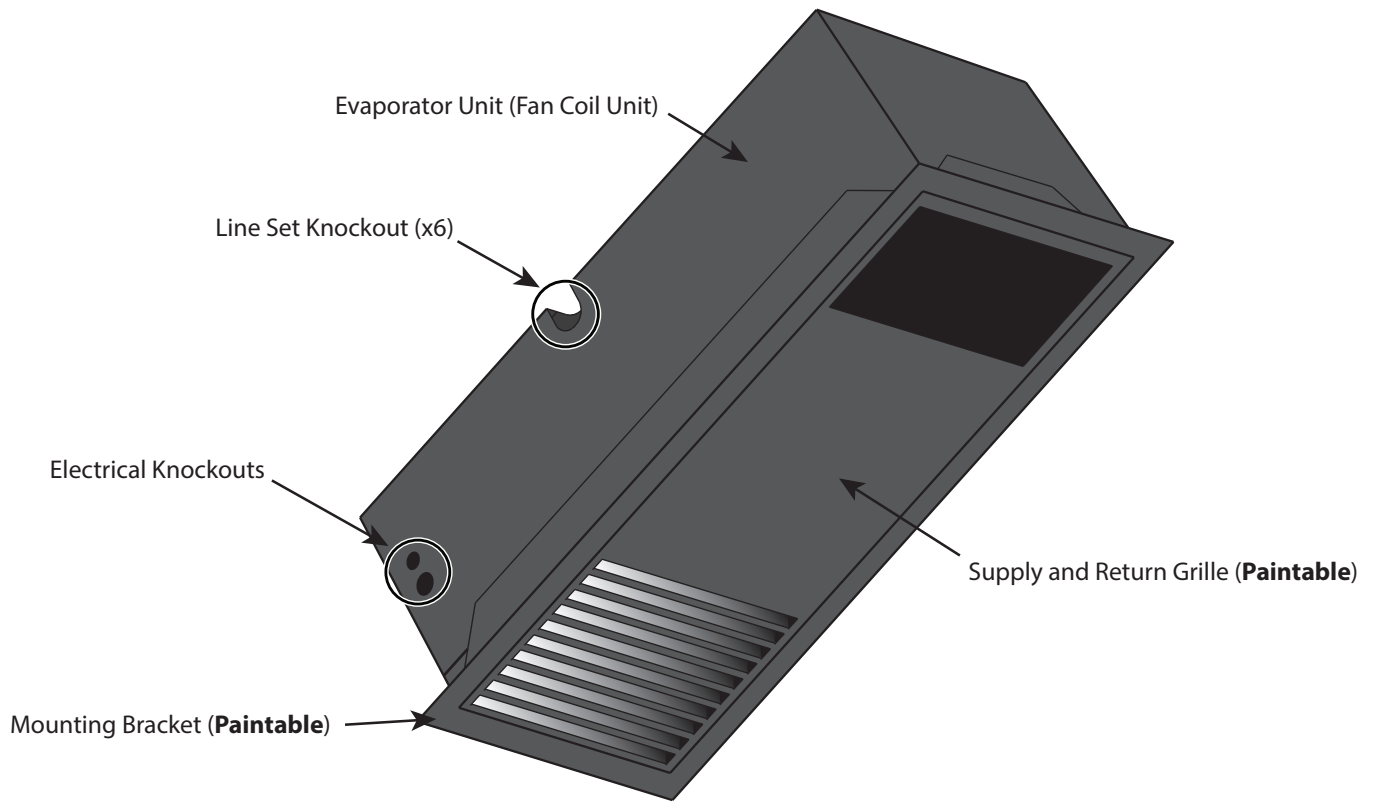

Top View

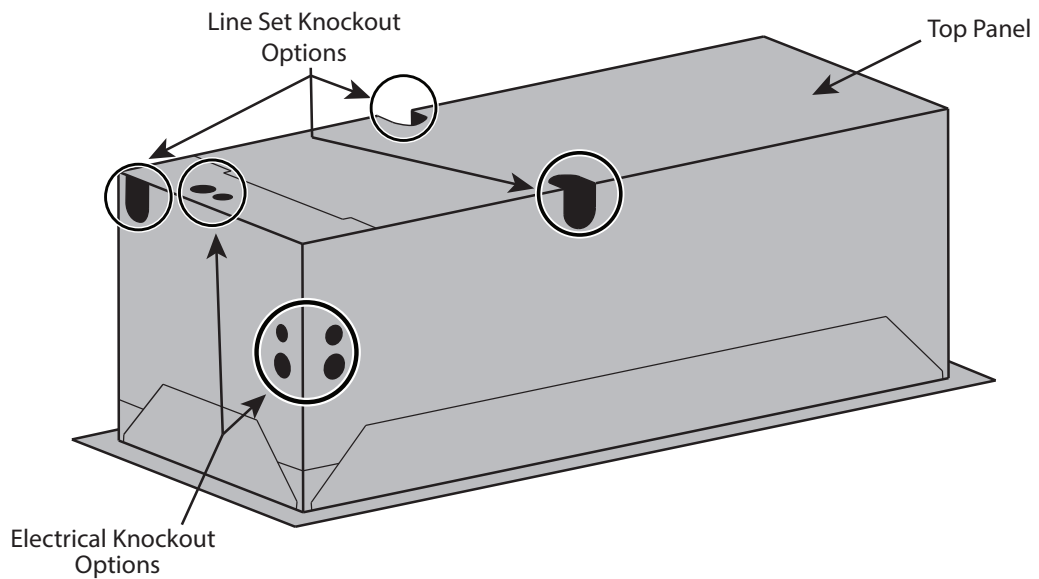

Note: The unit comes in black. The mounting bracket and front grille are paintable, enabling you to match your desired color.

KNOCKOUT LOCATIONS

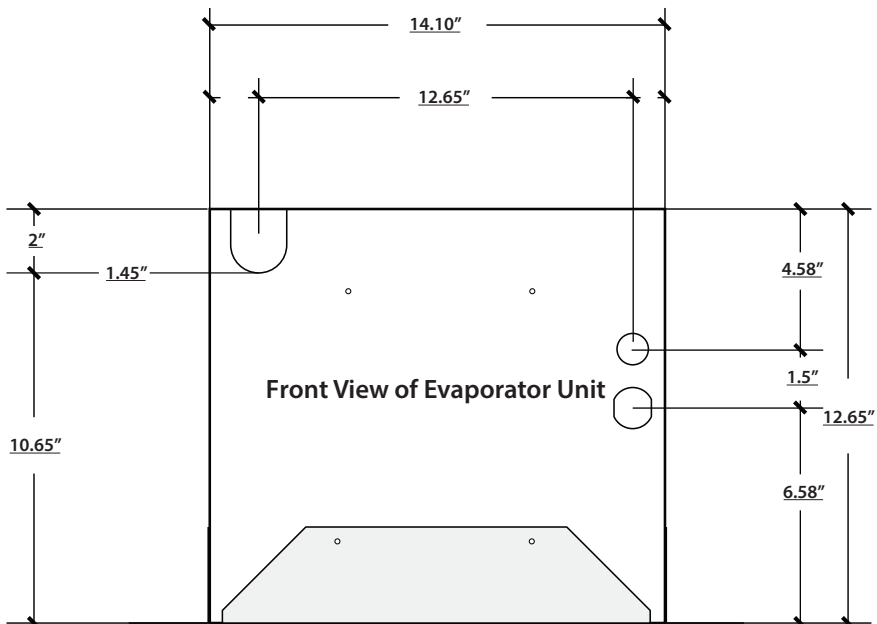
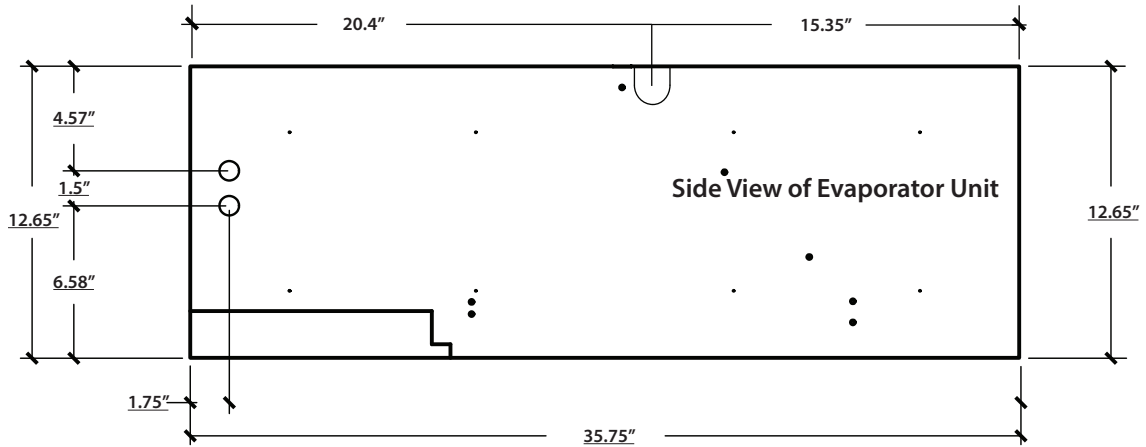
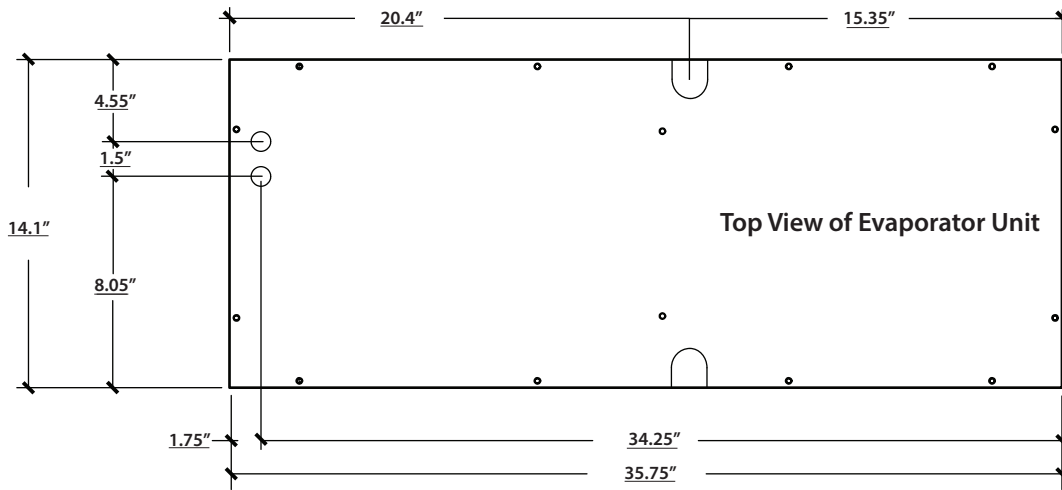

QUICK REFERENCE GUIDE

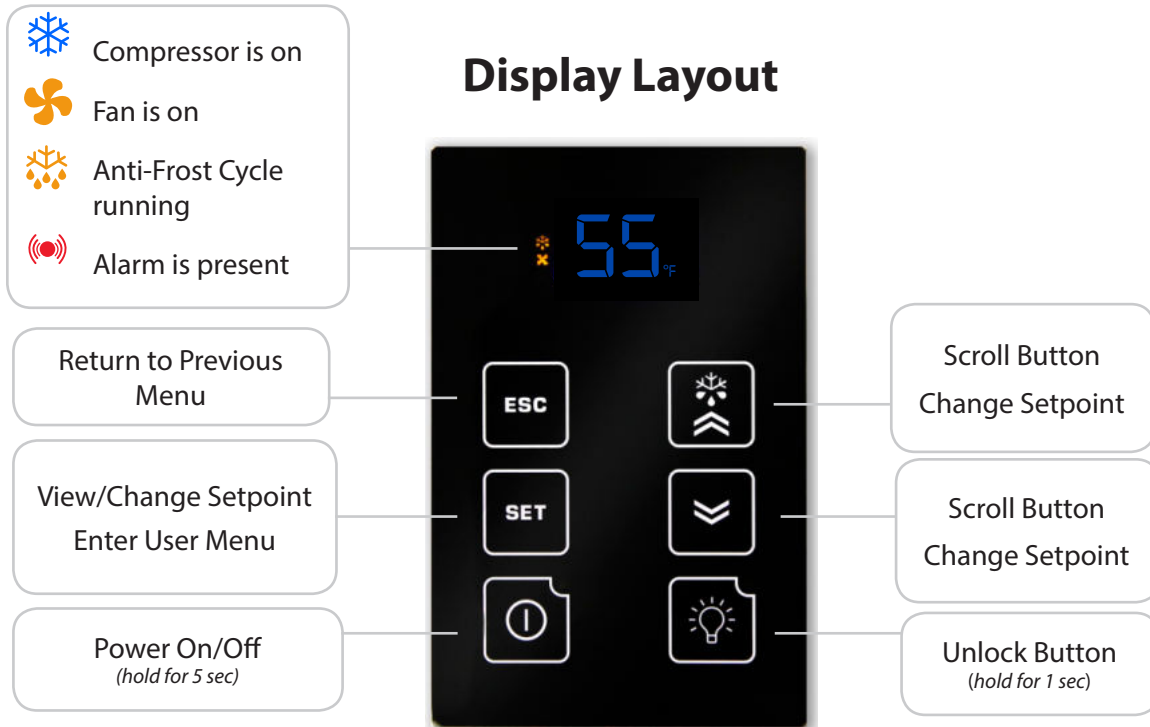

CEILING MOUNT TWIN SPECIFICATIONS

Model	9000 Evaporator (Fan Coil Unit)
Cellar Size (cu. ft.)	Approx. 3000
Dimensions	12.75"H x 14.5"W x 35.75"D (x2)
BTUh with 90° air entering the Condenser Coil*	8500
CFM	308
Refrigerant	R-404a
Voltage Rating	115V (20-amp dedicated circuit required)
Weight (lbs)	80
AMPS (Starting/Running)	2/1
dBA	58.5
Drain Line	¼" ID clear plastic tubing (not provided)
Installation	Evaporator units are installed through the cellar ceiling. Condensing unit is installed outside in a protective enclosure.
Thermostat	Remote digital display with 50-ft. cable and 50-ft. bottle probe
Temp. Delta	55°F max temperature differential between the cellar temperature and condensing unit air intake temperature
Warranty	Two-year limited warranty (parts and labor)

CEILING MOUNT TWIN SPECIFICATIONS

Model	9000 Condensing Unit
Cellar Size (cu. ft.)*	Approx. 3000
Dimensions	24"L x 17.5"W x 13.4"H
BTUh with 90° air entering the Condenser Coil	8500
CFM	270
Refrigerant	R-404a
Condensing Unit HP	3/4
Nominal Volts Hz-Ph	208/230-60-1
Weight (lbs)	67
Amps (Starting/Running)	27, 7.3
Installation	Evaporator units are installed through the cellar ceiling. Condensing unit is installed outside in a protective enclosure.
Temp. Delta	55°F max temperature differential between the cellar and condensing unit intake temperature
Warranty	Two-year limited warranty (parts and labor)

*** Sizing the System to the Room**

There are several factors such as glass, stone, and concrete which will change the required amount of BTUs needed to properly cool your wine room. We strongly recommend utilizing the cellar wizard on the WhisperKOOL website in order to ensure you are selecting the proper cooling system for your application. Under-sizing your cooling system can lead to premature failure and/or prevent the system from reaching the desired set temperature.

CONDENSING UNIT QUICK REFERENCE GUIDE

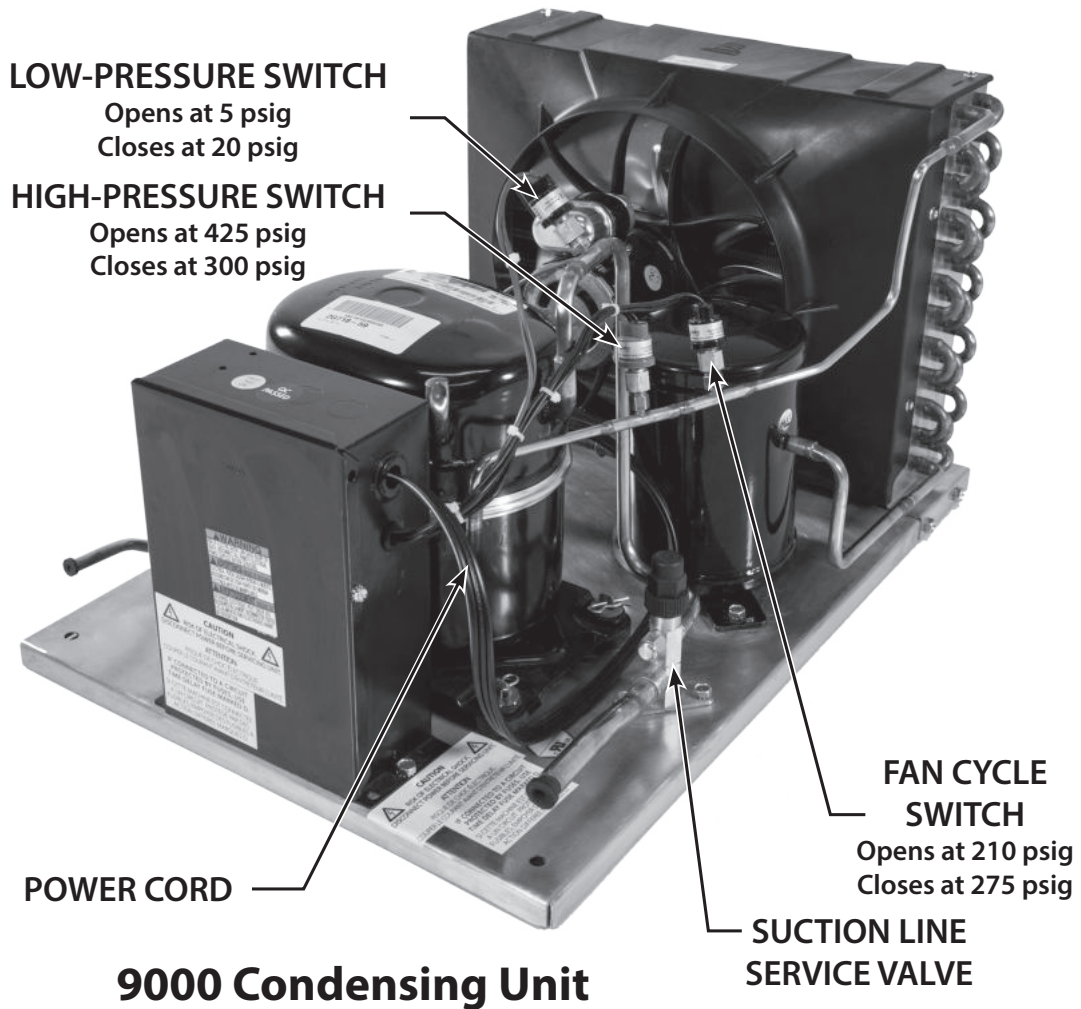

PREPARING THE WINE CELLAR

The performance and life of your system is contingent upon the steps you take in preparing the wine cellar. Improperly preparing your enclosure or incorrectly installing your unit may cause unit failure, leaking of condensation, and other negative side effects.

IT IS HIGHLY RECOMMENDED THAT YOU OBTAIN THE ASSISTANCE OF A WINE STORAGE PROFESSIONAL.

Wine storage professionals work with licensed contractors, refrigeration technicians, and racking companies to build well-insulated, beautiful, and protective wine cellars. WhisperKOOL has put together some useful tips to assist in the installation process. Our recommendations are meant to act as a guide in the process of building a proper enclosure. Your intended location may have specific needs which we do not address.

Wall and Ceiling Framing

Build wine cellar walls using standard 2x4 or 2x6 boards and ceiling joists without violating local or state codes in your area. As a general rule, the thicker the walls and the higher the insulation value, the more consistent your cellar temperature will be.

Insulation

Insulation is **REQUIRED** in order to properly use WhisperKOOL products. It is vital that all walls and ceilings be insulated to keep the cellar temperature as consistent as possible during the summer and winter months. Standard fiberglass or rigid foam insulation is normally used in cellar construction; in some cases, "blown-in" insulation is used. The R-value, or quality of insulation, is determined by the rate at which heat passes through the insulation. The higher the R-value, the more resistant the insulation is to conducting heat, and the more consistent your wine cellar's temperature will be. Using higher R-values in insulation will lower your operating costs and WhisperKOOL unit run time. (R-13 is the recommended minimum; R-19 is preferred for interior cellar walls, and R-30 for ceilings and exterior walls.)

Vapor Barrier

Water vapor creates its own pressure, separate from the ambient air pressure, and will intrude into colder/drier areas. A vapor barrier is **REQUIRED** in order to prevent the intrusion of water vapor and maintain the correct cellar temperature and humidity. It is recommended that 6-millimeter plastic sheeting be applied to the warm side of the cellar walls. The vapor barrier must also be applied to the outside walls and ceiling. If it is impossible to reach the outside, then the plastic must be applied from within the cellar. The most common method is to wrap the entire interior, leaving the plastic loose in the stud cavity so the insulation can be placed between each stud. All of the walls and ceiling must be wrapped in plastic for a complete vapor barrier.

In areas of high humidity, such as Southern and Gulf States, the vapor barrier will prevent infiltration of warm moist air. The moist air can cause mold to form, and standing water in drain pans promote microbial and fungal growth that cause unpleasant odors and indoor air quality problems. If mold is found, remove it immediately and sanitize that portion of the unit.

NOTE: High humidity significantly increases the heat load on the cooling system.

Any break in the vapor barriers (cut, nail hole, over-lapping, etc.) will cause a moisture leak and must be sealed. The electric conduit is a "duct" for vapor to travel in. The conduit should be caulked and sealed on the warm air end.



Unobstructed Airflow

Unobstructed airflow to and from the system is critical for the system's overall performance and lifespan. A minimum of 3 feet of clearance around the unit is crucial (5 feet is ideal). The air blown by the fans needs to circulate and either dissipate or absorb heat from the space. The system will operate more efficiently with a greater amount of air to exchange.

Note: Avoid attempting to camouflage the unit. This will restrict airflow, and thus the system's ability to work efficiently.



Door and Door Seal

An exterior-grade (1 $\frac{3}{4}$ "") door must be installed as a cellar door. It is very important that weather stripping is attached to all four sides of the doorjamb. A bottom "sweep" or threshold is also required. The door must have an excellent seal to keep the cool cellar air from escaping the cellar. If the door is not sealed properly, the cooling system may run continuously, shortening its operational lifespan.

In cases where glass doors are used and the room size is close to the recommended system size, the next larger size WhisperKOOL system should be used. This will compensate for the insulation loss due to the lower insulation rating of glass.

Ventilation

The necessity of dissipating heat away from the condensing unit is critical to the system's performance and cannot be overstated. As the system operates and cools, a greater amount of heat is generated on the condensing side of the system. Adequate ventilation is required in order to dissipate heat away from the condensing unit. If ventilation is inadequate, the exhaust will heat the area or room and adversely affect the system's ability to cool. In some cases, it may be advisable to install a vent fan to dissipate heat within the exhaust area on the condensing side of the system. However, you must have a fresh air inlet as well.

Note: If you are unsure whether you have adequate ventilation in your installation location, please contact us to assess your specific installation at 1-800-343-9463.

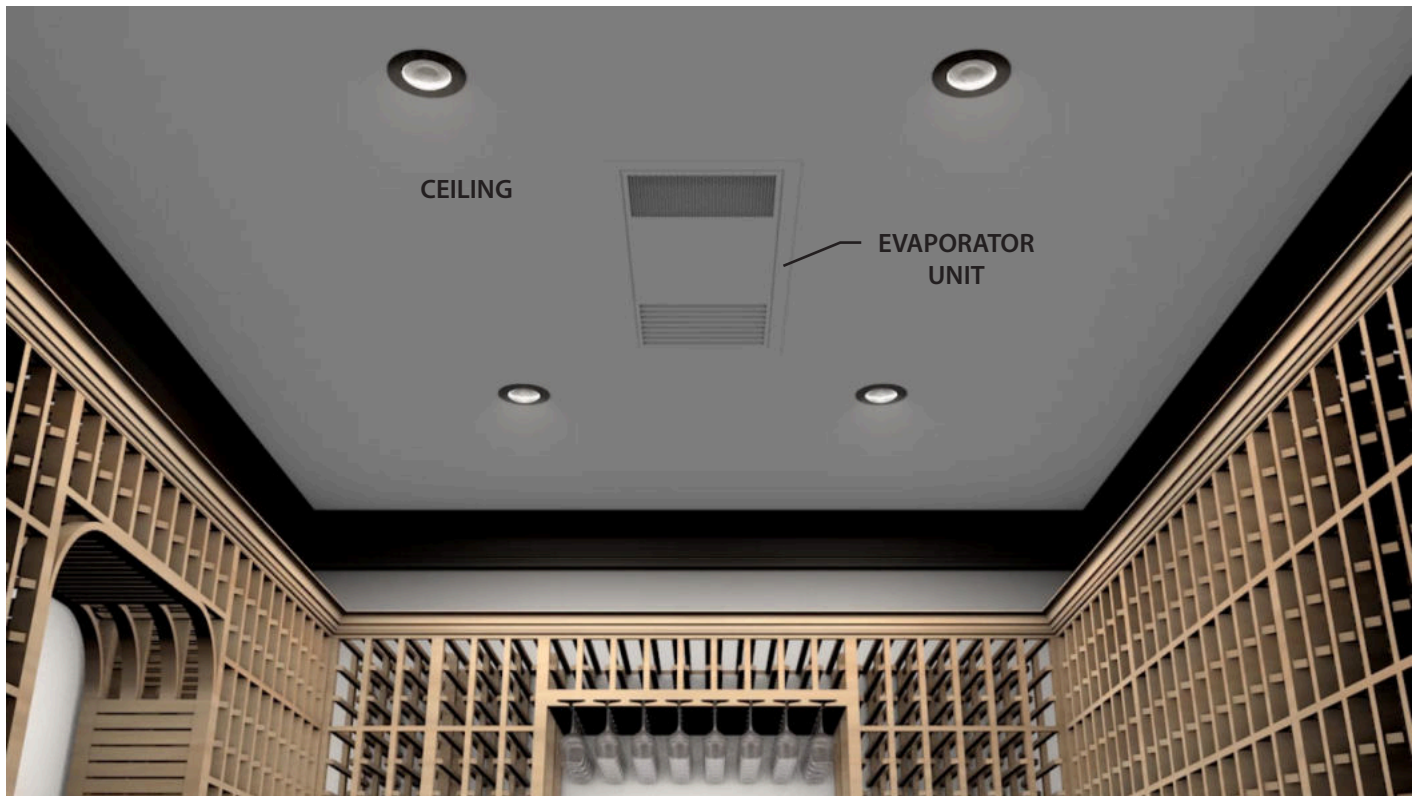

Note: The unit comes in black. The mounting bracket and front grille are paintable, enabling you to match your desired color.

Ambient Temperature Factor

The cooling system has the ability to cool a wine cellar efficiently to 55°F as long as the ambient temperature of the area to which it is exhausting does not exceed 110°F. Therefore, you the condensing unit to exhaust in a space which will not exceed 110°F, allowing for proper dissipation of the heat exhausted by the condensing unit. Without proper heat dissipation the system will not have the capacity to keep the wine at a desirable 55°F.



WARNING! Allowing your system to operate in high ambient temperatures for extended periods of time will greatly decrease the life of your system and void your warranty. The cooler the temperature of the air entering the condenser coil, the more cooling capacity the system has. The less heat gain through the common wall, the lower the consumption of electricity.



LIQUID-MEASURING THERMOSTAT SYSTEM (BOTTLE PROBE)

WhisperKOOL cooling systems come with a liquid-temperature-measuring thermostat. The self-calibrating probe contains a sensor chip, which communicates back and forth with the thermostat. This results in a consistent temperature setting and accuracy. Wine should be kept at a very precise, controlled temperature and humidity. By measuring the liquid temperature rather than air, the system will operate 75–80% of the time.

Setting up the Bottle Probe:

1. Locate an empty wine bottle.
2. Fill it 75% full with room-temperature tap water.
3. Place bottle probe securely into bottle as seen in Figure 1.
4. Place bottle off to the side of the master evaporator unit in your wine cellar, with the probe level.
5. To ensure a consistent temperature, place bottle probe approximately three (3) feet away from the air output and not in the flow of the air.

It is recommended that the bottle be placed in a central location of your wine cellar. Avoid pulling too much on the probe cord. It may become disconnected resulting in limited functionality of the system.

Note: The thermostat can be set between 55–70°F.

Remember: The system operates based on the temperature of the water. Do not be misled by thermostats reading air temperature. The air temperature in the cellar will be cooler than the liquid temperature of the wine while it is reaching the optimum balanced temperature.

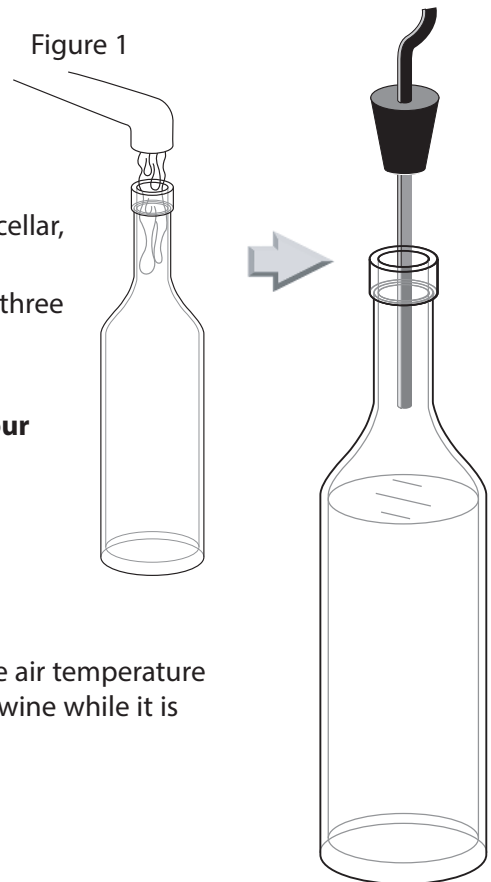

SYSTEM OPERATION

Initial Startup

When the units are plugged in and power is sent to the controller, a beep will sound, confirming that the controller is getting power. All LEDs on the display will blink three times. Three dashes will then appear on the screen. All display LEDs will then blink three times. Once the controller has gone through the initial startup process, and all LEDs have cycled, the home screen will be displayed.

Setpoint

The setpoint is preset at the factory to 55°F. It can be adjusted by the customer between 55–70°F in one-degree increments.

Indoor Fan Operation

The indoor fan will run when the controller is calling for cooling and turn off once the cooling cycle has ended. During the cooling cycle, the system will remove some relative humidity from the cellar. Some of the humidity that was removed can be reintroduced into the cellar by adjusting the “fan on” and “fan off” functions. (The cooling system is not equipped with a humidifier and does not add humidity.)

The FOF cycle should be shortened first. This will reduce the amount of time that the fan remains off following a cooling cycle. When the system has completed a cooling cycle, the compressor and the condenser fan will turn off, but the indoor fan will continue to run for whatever length of time the customer has set. The Fon function may then be lengthened to allow the fan to run longer and reintroduce moisture from the evaporator coil back into the wine cellar.

For more information about fan settings, refer to the User Menu on page 20.

Anti-Short Cycle

The Anti-Short Cycle ensures that the system will remain off for a period of five minutes after the system has reached the setpoint. This allows the pressure in the refrigeration system to equalize prior to starting the compressor.

Anti-Frost Cycle

When the evaporator probe senses a temperature of 26°F for a duration of one minute, an Anti-Frost Cycle will be initiated. This will shut down the compressor, allowing the evaporator fan to run and melt any frost accumulation on the coil. While the Anti-Frost Cycle is running, “dEF” will be displayed on the screen. The compressor will remain off until the evaporator coil reaches 40°F, or for a maximum of one hour. The system will then return to normal operation.

Operation in Low Ambient Temperatures

If the condensing unit is installed outdoors (where it will be exposed to low ambient temperatures), the condenser fan will cycle on and off. The purpose of the fan cycling is to maintain the system’s high side pressure, which will ensure an adequate refrigeration process.

Digital Display

The display is designed to give the user the ability to adjust the setpoint, Fon/FOF parameters, and other settings. (See User Menu on page 20 for more details.) The bottle probe temperature is displayed by default. “dEF” will be displayed during an Anti-Frost Cycle. The bottle probe and evaporator probe temperatures can be accessed by pushing the SET button and scrolling through “Pb1” (bottle probe) and “Pb2” (evaporator probe). The light button may be used as an unlock button.

Safety Features

In the event of a faulty bottle probe, the compressor will cycle off for 10 minutes and on for 40 minutes. “E1” will be displayed on the screen.

The evaporator units come equipped with a condensate pump to remove the condensation produced by the evaporator coils. The reservoir is mounted in the internal drip tray and will kill power to the units if the condensate level rises too high.

If the drain line is obstructed or the pump fails for some reason, and the water level in the drip tray gets too high, the units will not operate until the water in the internal drip tray drops back below the proper level.

In this event the controller will send an alarm to the display. (The alarm message, EA, can be viewed in the User Menu’s ALr folder.)



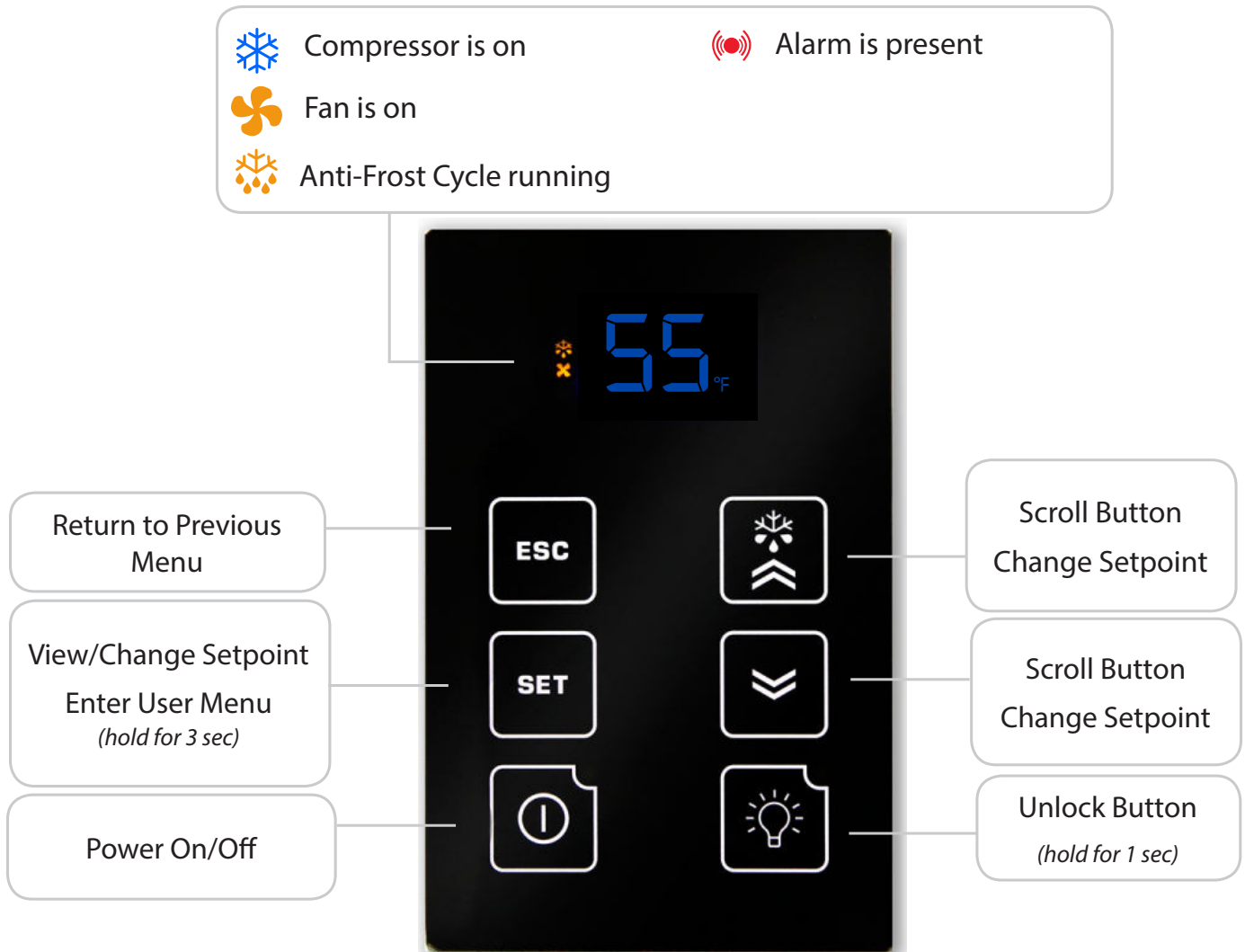

Alarms

See “Alarm Codes” in the Controller Functions chart.





DISPLAY LAYOUT





CONTROLLER FUNCTIONS

Button	Normal Functions								
INITIAL STARTUP	When the system is plugged in and power is sent to the controller, a beep will sound, confirming that the controller is getting power. All LEDs on the display will blink three times. Three dashes will then appear on the screen. All display LEDs will then blink three times. Once the controller has gone through the initial startup process, and all LEDs have cycled, the home screen will be displayed.								
UNLOCKING THE DISPLAY	Press and hold any button for one second to unlock the display. (A white LED will appear in the top left corner of the button being pressed.) A beep will sound, signifying that the display is unlocked. NOTE: The display must be unlocked before any button functions become available.								
ON/OFF 	<p>To turn the system ON, press and hold the ON/OFF button until the red LED turns OFF.</p> <p>To turn the system OFF, press and hold the ON/OFF button until the red LED turns ON.</p>								
UP/DOWN 	The up and down arrows are used to navigate through menus and adjust parameters such as setpoint, Fon/FOF, etc.								
SET 	<ul style="list-style-type: none"> To change the setpoint, press the SET button. When "SEt" is displayed on the screen, press the SET button once more. Use the UP and DOWN ARROW buttons in order to change the value until the desired setpoint is reached. The SET button allows you to view the setpoint, evaporator temperature, bottle temperature, alarms, and the hidden menu. Press the SET button once. "SEt" will be displayed. Press the UP or DOWN ARROW buttons to scroll through ALr, Pb1, or Pb2. <table border="1" data-bbox="467 1184 1511 1352"> <thead> <tr> <th>Set</th> <th>Setpoint</th> </tr> </thead> <tbody> <tr> <td>ALr</td> <td>Alarm folder</td> </tr> <tr> <td>Pb1</td> <td>Liquid (bottle probe) temperature</td> </tr> <tr> <td>Pb2</td> <td>Evaporator coil temperature</td> </tr> </tbody> </table> <ul style="list-style-type: none"> Press the SET button again to view any of these values. Hold the SET button for approximately 5 seconds to enter the User Menu. (More information about the User Menu is available on page 20.) Other parameters in the User Menu which are not available for adjustment include: idF, rEL, and LAN. 	Set	Setpoint	ALr	Alarm folder	Pb1	Liquid (bottle probe) temperature	Pb2	Evaporator coil temperature
Set	Setpoint								
ALr	Alarm folder								
Pb1	Liquid (bottle probe) temperature								
Pb2	Evaporator coil temperature								
ESC 	This button confirms changes made to parameters such as the setpoint and returns you to the previous menu.								
LIGHT 	The light function is not in use. However, this button can still be used to unlock the display.								

ICON GLOSSARY

Icon	Meaning
<p>SNOWFLAKE</p> 	<p>Blinking: The thermostat is calling for cooling, but must wait five minutes before restarting the compressor. This five-minute delay serves as an Anti-Short Cycle for the compressor's protection.</p> <p>Constant: The system is in cooling mode and the condensing unit is running.</p>
<p>DRIPPING SNOWFLAKE</p> 	<p>The system is undergoing an Anti-Frost Cycle. While the Anti-Frost Cycle is running, "dEF" will be displayed on the screen. See System Operation page for further details.</p>
<p>FAN</p> 	<p>The evaporator fan is running.</p>
<p>ALARM</p> 	<p>The alarm icon is shown when the system encounters an issue that needs attention. Alarm codes are explained on the following page. All temperature-related alarms are blocked for the first 10 hours after the system is plugged in to allow the system to stabilize and acclimate to the new environment.</p>

ALARM CODES

Code	Cause	Solution
The following alarm codes will be displayed on the screen along with the alarm icon. 		
E1	Bottle probe is not connected	Attach bottle probe to circular connector (see instructions on page 18 of the technician's manual)
	Faulty bottle probe connection	Locate faulty bottle probe connection by inspecting all wiring connections between the bottle probe and the circuit board. The two-pin connector for the bottle probe should be connected to the CPB/PB1 terminal on the circuit board. If it is not connected, plug it in. If a faulty connection has been identified, correct the issue or contact customer service for further assistance. NOTE: The E1 code will not appear in the alarms menu. It will be permanently displayed on the screen.
	Defective bottle probe	Replace the bottle probe
E2	Faulty evaporator probe connection	Locate faulty evaporator probe connection by inspecting evaporator probe wire. The two-pin connector for the evaporator probe should be connected to the CPB/PB2 terminal on the circuit board. If it is not connected, plug it in.
	Defective evaporator probe	Replace the evaporator probe
E7	No communication between keypad and circuit board for 60 seconds	Verify that the display cable is connected to the keypad and the circuit board and is not damaged, frayed, or kinked. If problem persists, contact Customer Service for troubleshooting information.
E10	Clock battery is dead	Replace battery NOTE: A dead clock battery will not affect the operation of your cooling unit.
The following alarm codes will not be displayed on the home screen. However, the alarm icon will be displayed in the event of an alarm. The alarms can be viewed in the Set Menu's ALr folder. 		
EA	Unit is not draining properly	<ol style="list-style-type: none"> 1. Check to see that the unit is level; if not, level it 2. Verify that the drain line is not clogged; if so, clear obstruction 3. Ensure that the condensate pump is operating <p>NOTE: If the drain line is obstructed or the pump fails for some reason, and the water level in the drip tray gets too high, the unit will not operate until the water in the internal drip tray drops back below the proper level.</p> <p>NOTE: If the unit loses power (due to a power outage or being manually unplugged), the condensate pump may need to be reset. To do this, disconnect and reconnect the black cables on the condensate pump.</p>
AH1	The bottle probe is sensing a temperature that is 4°F above the setpoint	<ol style="list-style-type: none"> 1. Allow time for the wine to reach the desired temperature 2. Ensure that the cellar is sealed properly 3. Verify that the bottle probe is calibrated correctly (refer to the User Menu on the following page) 4. Verify that the unit is sized correctly for the cellar
AL1	The bottle probe is sensing a temperature that is 4°F below the setpoint	<ol style="list-style-type: none"> 1. Make sure the unit is not in cooling mode (the snowflake icon will not be illuminated) 2. Add heat to the room until the wine reaches the desired temp 3. Verify that the bottle probe is calibrated correctly (refer to the User Menu on the following page)
Ad2	The Anti-Frost Cycle ended on time-out	<ol style="list-style-type: none"> 1. Check the evaporator coil for ice buildup. Unplug the unit and allow the coil to thaw before restarting. 2. Make sure the room to which the unit is exhausting is not below 60°F 3. If the unit repeatedly goes into Anti-Frost Cycles (one per minute), call Customer Service for more troubleshooting information

USER MENU

The User Menu is accessed by **pressing and holding the SET button for 3 seconds**. Use the UP and DOWN ARROW buttons to navigate to desired parameters. Press the SET button again to view these parameters. Press the UP and DOWN ARROW buttons to adjust a parameter.

The following parameters are available in the menu:

Parameter	Description
Fdc - humidity enhancement	This parameter is measured in minutes, and is preset at the factory to 1. An increase in this parameter will increase the humidity enhancement of your cellar. This parameter should not be adjusted to zero. Adjustments should be made in increments of 5, with a maximum of 15 and a minimum of 1. After making any adjustments to humidity enhancement, you should wait a minimum of 3 days before making any additional adjustments. This will allow sufficient time for the cellar to acclimate to the new setting.
FOF - "fan off"	This setting controls how long the fan stays off after the setpoint has been reached. It is preset to 15 minutes. This setting should not be adjusted, as most properly constructed wine cellars retain an ample amount of humidity during the "fan off" cycle. If, however, you wish to decrease the duration of the "fan off" cycle (in order to increase the wine cellar's relative humidity), you can adjust this setting in the User Menu.
Fon - "fan on"	The "fan on" time is preset to zero minutes. This keeps the relative humidity of the wine cellar at a stable level. If, however, you wish to raise the relative humidity of your wine cellar, you can increase the duration of the "fan on" cycle in increments of five (5, 10, or 15 minutes). After making any adjustment to the "fan on" cycle, you should wait a minimum of 3 days before making any additional adjustments. This will allow sufficient time for the cellar to acclimate to the new setting.
CA1 - bottle probe (Pb1) calibration	CA1 - bottle probe (Pb1) calibration: You may use this parameter to calibrate the bottle probe to a known temperature. This parameter can be adjusted between -12°F and 12°F. For example, if the bottle probe temperature is 58°F, and the known temperature is 55°F, you can set the CA1 parameter to -3°F to match the known temperature.
PA2 - installer menu	This menu is only accessible using a password and is not available for adjustment.

NOTES

TROUBLESHOOTING GUIDE

Ice forming on evaporator units	
Possible cause	Solution
Evaporator filter or coil is dirty	Remove the filter and wash it, then clean the coil with a vacuum. If coil is very dirty, use a spray bottle with a small amount of liquid dish detergent or coil cleaner. Spray coil, let set for five minutes, then flush with fresh water.
There is something blocking the supply and/or return air	Remove blockage
The evaporator fan is not turning on	Call a service tech to troubleshoot
The evaporator units have not gone through an Anti-Frost Cycle yet	Check the coil for surface ice. Melt with blow drier until coil is warm to the touch. Soak up water with a towel.
If evaporator units continue to ice	Observe ice formation pattern. If only part way up the coil face, the system could be low on refrigerant. If all the way up, the coil may be dirty or airflow is blocked.
System does not run/power up	
Possible cause	Solution
Evaporator units are not plugged in	Make sure the units are plugged into an outlet
Power switch not on	Turn system on by pressing the power button on the control
Line voltage rating is incorrect for the system	Check line voltage to make sure there is 110V-120V
Setpoint at setpoint	Lower setpoint
Thermostat not calling for cooling	Lower setpoint
Faulty thermostat or wiring	Call Customer Service at 1-800-343-9463
Cellar temperature is too warm	
Possible cause	Solution
The temperature of the room to which the condensing unit exhausts exceeds 110°F	Intake temperature needs to drop below 110°F
The system is undersized for the cellar	Order correctly sized system
There is something blocking the supply and/or return air on the evaporator units or the condensing unit	Remove air flow obstruction
Evaporator units are mounted too low in the cellar	Relocate units so the distance from the ceiling and top of the units is no more than 18"
One or more of the fans is not turning on	Please contact the installing technician to troubleshoot
Compressor is not turning on	Please contact the installing technician to troubleshoot
Compressor keeps cycling on overload	Make sure all fans are working and there is no airflow obstruction
Poor seal around door or other areas requiring a seal (around the evaporator units, wall joints, etc.)	Make sure there are no air gaps around the door. If door seal is damaged, replace it.
Setpoint too high	Lower the setpoint
Evaporator coils are frosted or iced up	Observe ice formation pattern. If only part way up the coil face, evaporator units could be low on refrigerant. If so, contact your installing technician to assist with troubleshooting.
System runs constantly	
Possible cause	Solution
Leaky door seal or poorly insulated cellar	Fix leaky door seal and insulate cellar

Units leaks water

Possible cause	Solution
Evaporator units are not level	Evaporator units should be level on the wall to prevent leaking
Drain line clogged or kinked	Check drain line to make sure water can flow freely
Drain is clogged, preventing water from escaping	Disconnect drain and clear it out; check drain for blockage
Drain lines do not have a downward slope	Fix drain line so there is a downward slope from the units to the drain
Coil is iced, causing drain pan to freeze and water to overflow	Melt ice with blow drier. Soak up with a towel.
Condensate pump needs to be reset	Disconnect and reconnect the black cables attached to the pump

System runs but does not cool

Possible cause	Solution
Lack of air flow	Make sure fan is unobstructed and that the evaporator filter, evaporator coil, and condenser coil are clean and free of debris
System undersized	Contact Customer Service at 1-800-343-9463
Compressor is overheating	Shut system off for 1 hour to allow compressor to cool. Turn back on and check for cooler air flow out. If compressor runs, check for and clean condenser coil as possible cause of compressor overheating. If problem repeats, contact you installing technician to assist with troubleshooting.

Evaporator fan runs but compressor does not

Possible cause	Solution
Running an Anti-Frost Cycle	1) If the system is maintaining the correct cellar temperature and there is a dripping snowflake symbol illuminated on the control, the system is going through an Anti-Frost Cycle. No action is required. 2) If the system is not maintaining the correct cellar temperature, this may be due to a dirty evaporator filter or coil. 3) Call installing technician to troubleshoot, as the system may be low on charge or require an adjustment to the TXV.
Compressor and/or starting components faulty	Please contact the installing technician to troubleshoot
System may be performing the WHM function	Allow cooling system to revert back to cooling mode
Compressor may have overheated	Shut system off for 1 hour to allow compressor to cool. Turn back on and check for cooler air flow out. If compressor runs, check for and clean condenser coil as possible cause of compressor overheating. If problem repeats, contact your installing technician to assist with troubleshooting.

Compressor runs but evaporator fan does not

Possible cause	Solution
Faulty fan motor	Please contact the installing technician to troubleshoot
Faulty controller	Please contact the installing technician to troubleshoot

Compressor short cycles

Possible cause	Solution
Evaporator units blow on bottle probe	Move bottle probe to a more central location
System low on refrigerant charge	Please contact the installing technician to troubleshoot
Condensing fan motor/capacitor faulty	Please contact the installing technician to troubleshoot
Compressor and /or starting components faulty	Please contact the installing technician to troubleshoot

Humidity in cellar too low

Possible cause	Solution
Not enough moisture	Purchase and place a humidifier (or a decorative fountain) in cellar

MAINTENANCE SCHEDULE

Monthly	<ol style="list-style-type: none">1. Check coils2. Check for unusual noise or vibration3. Check the drain line to see if it is above the waterline (if draining into a vessel)
Quarterly	<ol style="list-style-type: none">1. Use a vacuum with brush attachment to clean coils; be careful not to crush coil fins when cleaning2. Change duct filter if the system is ducted
Annually	<ol style="list-style-type: none">1. Inspect for corrosion2. Check wiring connections and integrity of cords3. Pour a 50/50 bleach solution into the drain line every spring

TECHNICAL ASSISTANCE

WhisperKOOL Customer Service is available Monday through Friday from 6:00 a.m. to 4:00 p.m. Pacific Standard Time.

The appointed customer service representative will be able to assist you with your questions and warranty information more effectively if you provide them with the following:

- The model and serial number of your WhisperKOOL system(s).
- Location of system and installation details, such as ventilation, ducting, construction of your wine cellar, and room size.
- Photos of the cellar and installation location may be needed.

Contact WhisperKOOL Customer Service

1738 E. Alpine Ave
Stockton, CA, 95205

Phone: 209-466-9463
US Toll Free: 1-800-343-9463
Fax: 209-466-4606

ACCESSORIES FOR COOLING SYSTEMS

WhisperKOOL offers accessories to enhance and customize your wine cooling system:

Condensate Pump Kit

The condensate pump kit automatically removes water that drips out of the evaporator units' drain lines. The pump is controlled by a float/switch mechanism that turns the pump on when approximately 2¼" of water collects in the tank, and automatically switches off when the tank drains to approximately 1¼". The condensate pump kit allows the excess condensate to be pumped up to 20 feet away from the system.

Exterior Housing

If the condensing unit is installed outside, it will need protection from sun, wind, and rain. The exterior housing protects the condensing unit portion of the split system from the elements when installed outdoors.

WhisperKOOL Product Terms and Conditions
Including Product Limited Warranty And Product Installation Requirements
For WhisperKOOL Split System Series

ATTENTION: PLEASE READ THESE TERMS OF USE CAREFULLY BEFORE INSTALLING YOUR WHISPERKOOL COOLING SYSTEM. INSTALLING YOUR WHISPERKOOL COOLING SYSTEM INDICATES THAT YOU ACCEPT AND AGREE TO EACH OF THE TERMS AND CONDITIONS SET FORTH HEREIN ("TERMS OF USE"). IF YOU DO NOT ACCEPT THESE TERMS OF USE, YOU RISK VOIDING YOUR WARRANTY AND ASSUMING ADDITIONAL REPAIR AND REPLACEMENT COSTS.

1. Purchase of a WhisperKOOL Cooling System assumes that the Purchaser ("End User") fully accepts and agrees to the Terms and Conditions set forth in this document. The Terms and Conditions of Sale and Owner's Manual are shipped with each unit and, if another copy is needed, replacement copies can be downloaded from the company website or by contacting WhisperKOOL directly for a new copy. WhisperKOOL reserves the right, in its sole discretion, to change its Terms and Conditions at any time, for any reason, without notice.

2. WhisperKOOL Product Installation and Limited Warranty

- A. Purchaser of the product must arrange for the product to be installed by a certified HVAC/R technician in accordance with procedures set forth by WhisperKOOL and described in the WhisperKOOL Owner's Manual.
- B. The HVAC/R technician installing the product must complete the designated portion of the Split Startup Checklist and provide licensing or certification identification number information to assist in the warranty registration process.
- C. Purchaser must return the completed Split Startup Checklist to WhisperKOOL within thirty (30) days of installation of Product. The Split Startup Checklist must be approved by WhisperKOOL to activate the Limited Warranty. If the Split Startup Checklist is approved, Purchaser will be sent activation approval documents and will start receiving the benefits of the Limited Warranty throughout the warranty period. If the Split Startup Checklist is incomplete, Purchaser will be informed they have five days to complete the Split Startup Checklist and re-submit to WhisperKOOL. The Split Startup Checklist will be reviewed again, and if denied, Purchaser will be informed that they have 10 business days for corrective action. Failure to register the Product may result in loss of warranty.
- D. Purchaser is responsible for the full costs of installation and any additional parts required for the proper and complete installation of the product.
- E. For Split Systems returned to WhisperKOOL in accordance with the terms and conditions of the Limited Warranty, WhisperKOOL warrants against defects in material and workmanship as follows:
 1. **LABOR** — For a period of two (2) years commencing on the date of purchase, WhisperKOOL will, at its option and discretion, reimburse up to \$250 to the End User for cost incurred for servicing, repairing, removing or installing warranty parts. Invoice for service must be forwarded to WhisperKOOL for assessment and processing. The Split System warranty is invalid if there is attempted repair by anyone other than an HVAC/R technician approved by WhisperKOOL to service the Product.
 2. **PARTS** — For a period of two (2) years commencing on the date of purchase, WhisperKOOL will supply, at no charge, new or rebuilt replacement parts in exchange for defective parts. Replacement parts are warranted only for the remainder of the original warranty period.
 3. **FREIGHT** — For a period of two (2) years commencing on the date of purchase, if after WhisperKOOL approved evaluation the original Product failure is determined to be the cause of a manufacturers defect, and not the cause of an installation error or other cause, WhisperKOOL will cover at its option, freight for the replacement parts or Product.

The following part or cause of failure is not the responsibility of WhisperKOOL:

- Improper voltage supply
- Line set with screw connectors (high end and low end)
- Leaks found at the braze points when performing pressure check
- Unit that has been charged incorrectly

- Incorrect tubing diameter used on line set
- A unit that has been wired incorrectly
- Valve stem on condenser side
- Improper installation of P-Trap
- Lack of P-Trap (if required)
- Condensers that are installed outdoors or in elements that would affect operation without proper cover or housing. (Housing is available from Manufacturer).

Product Warranty Limitations and Exclusions.

1. This limited warranty does not cover cosmetic damage caused during installation, damage due to acts of God, commercial use, accident, misuse, abuse, negligence, or modification to any part of the Product. Delivery and installation of the Product, any additional parts required, as well as removal of the Product if warranty work is required, are all at the sole cost, risk and obligation of the End User.
2. This limited warranty does not cover damage due to improper installation or operation or lack of proper maintenance of the Product, connection of the Product to improper voltage supply, or attempted repair of the Product by anyone other than a technician approved by WhisperKOOL to service the Product.
3. This limited warranty does not cover any Product sold "AS IS" or "WITH ALL FAULTS."
4. Product that has been replaced during warranty period does not extend the warranty period past the original date of purchase.
5. This limited warranty is valid only in the continental United States. Sales elsewhere are excluded from this warranty.
6. Proof of purchase of the Product in the form of a bill of sale, receipted invoice or serial number, which is evidence that the Product is within the Limited Warranty Period, must be presented by the End User to WhisperKOOL in order to obtain limited warranty service.
7. This limited warranty is void if the factory applied serial number has been altered or removed from the Product.
8. This limited warranty is voided if installed in an enclosure of insufficient design that does not follow the Product installation requirements stated herein and in the owner's manual.
9. Removing the rivets from the Product's unit housing without prior authorization from WhisperKOOL voids this limited warranty.
10. The End User must first contact WhisperKOOL Customer Service by telephone (at 1-800-343-9463) prior to attempting service on any Product still under the limited warranty; else the limited warranty is voided.
11. This limited warranty does not cover Product being concealed by, but not limited to, vegetation, fabric, shelving, mud, snow, or dirt. Product must not be painted or limited warranty will be void.
12. This limited warranty does not cover exposure to corroding environments such as, but not limited to, petroleum and gasoline products, cleaning solvents, caustic pool chemicals, and marine air.
13. This limited warranty does not cover any cause not relating to Product defect.
14. THE REPAIR OR REPLACEMENT OF THE PRODUCT AS PROVIDED UNDER THIS LIMITED WARRANTY IS THE EXCLUSIVE REMEDY OF YOU, THE END USER, AS WELL AS ANYONE ELSE IN THE CHAIN OF TITLE OF THE PRODUCT, DOES NOT START A NEW LIMITED WARRANTY TIME PERIOD, AND IS IN LIEU OF ALL OTHER WARRANTIES (EXPRESS OR IMPLIED) WITH REGARD TO THE PRODUCT. IN NO EVENT SHALL WHISPERKOOL BE LIABLE FOR INCIDENTAL, CONSEQUENTIAL, SPECIAL OR CONTINGENT DAMAGES FOR BREACH OF ANY EXPRESS OR IMPLIED WARRANTY ON THIS PRODUCT. THE IMPLIED WARRANTIES OF MERCHANTABILITY
15. AND FITNESS FOR A PARTICULAR PURPOSE ARE HEREBY EXPRESSLY DISCLAIMED. Some states do not allow the exclusion or limitation of incidental or consequential damages, or allow limitations on how long an implied warranty lasts, so the above limitations or exclusions may not apply to you. This limited warranty gives you specific legal rights, and you may have other rights, which vary from state to state.
16. Failure of the End User to comply with all of the Product Installation Requirements, Maintenance Requirements and End User Requirements may, at WhisperKOOL's sole discretion, void this limited warranty.
17. No one has any authority to add to or vary the limited warranty on this Product.

3. Maintenance Requirements

The End User is responsible for checking the coils on the condenser unit and vacuuming them every three months to maintain them free of debris. It is the End User's responsibility to clean off any accumulated dust, lint, or other debris from the front and rear intake grills; failure to do this on a regular basis will restrict the airflow and may affect the Product's ability to function properly. Periodically cleaning the Product's vents will help assure maximum cooling efficiency. The drain tube must also be checked and kept clean and free of debris and mold to maintain proper performance.

Mold is a natural living organism in the environment. It exists in the air in the form of microscopic spores that move in and out of buildings through doors, windows, vents, HVAC systems and anywhere else that air enters. Once it is discovered, mold must be addressed quickly and appropriately. Delayed or improper treatment of mold issues can result in costly and reoccurring repairs. If the End User suspects a mold problem, it is always best to hire a qualified and experienced mold remediation specialist.

4. Additional End User Costs And Responsibilities

Terms and conditions for replacing the Product that is being evaluated for limited warranty.

1. After evaluation by a certified HVAC/R technician and the Product is found to be irreparable in the field, contact WhisperKOOL Customer Service to arrange for replacement under the warranty guidelines. When a claim for warranty is submitted for a condenser skid, the End User must purchase a new condenser skid from WhisperKOOL at retail price. Upon installation of the new condenser skid by a certified HVAC/R Technician, the HVAC/R Technician must complete the Installation Checklist and End User must submit the Installation Checklist to WhisperKOOL Customer Service for approval. The original condenser skid must be returned within 21 days to WhisperKOOL for failure analysis. If the Installation Checklist is approved and the failure is evaluated as defective and not installation error or other reason, the End User will be refunded for the cost of the replacement skid.
2. If the Product failure is evaluated and it is determined that it is an installation error or other reason, all costs, including shipping will be the responsibility of the End User.

The following items are not covered under any warranty and are the sole responsibility of the End User:

- A. End Users should satisfy themselves that the Product they are purchasing is suitable for their particular needs and requirements, and thus no responsibility will be placed with WhisperKOOL for the End User's decisions in this regard.
- B. End Users must assure that the product is installed by a certified HVAC/R technician. Failure to do so will result in Voiding the Limited Warranty.
- C. It is the End User's responsibility to secure safe haven/storage for ANY AND ALL items that are being kept and stored in the End User's wine cellar, including any Product. WhisperKOOL takes no responsibility for the safety and preservation of the aforementioned items in the event that the environment becomes unsuitable to maintain a proper storage environment.
- D. End User is responsible for initial installation costs, including, but not limited to, labor costs and the cost of any additional parts necessary to complete the installation.
- E. End User is responsible for all costs incurred for the installation and/or removal of the Product, or any part thereof, unless such cost has been agreed by WhisperKOOL to be a warranty repair prior to the work being performed.

5. Sales and Use Tax

WhisperKOOL only collects California sales tax for orders shipped within the State of California; WhisperKOOL does not collect sales tax for orders shipped to other states. However, the Purchaser and the End User may be liable to the taxing authority in their state for sales tax and/or use tax on the Product. The Purchaser and the End User should each check with their state's taxing authority for sales and use tax regulations.

6. Customer Service and Troubleshooting

WhisperKOOL's customer service department is available to answer any questions or inquiries for End Users regarding a WhisperKOOL Product, as well as to assist in performing basic troubleshooting, Monday through Friday, from 6:00 a.m. to 4:00 p.m. PST, at telephone number 1-800-343-9463. WhisperKOOL reserves the right to have a certified, WhisperKOOL-approved, HVAC/R technician go on site and inspect the product if the initial trouble shooting warrants further investigation. WhisperKOOL Corporation is located at 1738 East Alpine Avenue, Stockton, California 95205.

7. Request for Product Evaluation and Repair Under Warranty

SPLIT SYSTEM FIELD SERVICE WARRANTY POLICY: This Policy is to clarify what falls under Warranty Service and what becomes the responsibility of the Owner. WhisperKOOL (“manufacturer”) strives to provide our customers with a superior Product and we back our Product with a Two Year Limited Warranty. Please review the WhisperKOOL Product Terms and Conditions including Product Limited Warranty and Product Installation Requirements to ensure you have a complete understanding of our Policy and coverage of your Split System.

ARBITRATION: Any disputes arising out of or in connection with the installation and warranty of the Split System shall be referred to and finally resolved by a WhisperKOOL approved Independent Certified HVAC/R Technician. The evaluation of the Technician on all issues or matters of identifying the responsible party (WhisperKOOL or Installing Technician) shall be determined in a written report. This report will be made available to all concerned parties. If discovered under warranty, WhisperKOOL will assume the financial responsibility under their warranty guidelines. If the report finds the Owner’s Installer as the responsible party, WhisperKOOL will provide all documentation to the customer to substantiate the findings. This will include the Invoice from the Independent Certified HVAC/R Technician and the written report of the findings. The Owner will become responsible for payment directly to WhisperKOOL for all charges incurred for repairs (labor, parts and shipping costs) on the Split System.

8. Miscellaneous Terms and Conditions

- A. Return Policy. All return inquiries must be made within thirty (30) calendar days of the original purchase of a Product and are subject to a twenty five percent (25%) restocking fee. Shipping costs are not refundable and the Purchaser is responsible for all return shipping costs (including customs fees and duties, if applicable).
- B. Security Interest. WhisperKOOL retains a security interest in each Product until payment in full.
- C. Construction and Severability. Every provision of these Terms and Conditions shall be construed, to the extent possible, so as to be valid and enforceable. If any provision of these Terms and Conditions is held by a court of competent jurisdiction to be invalid, illegal or otherwise unenforceable, such provision will, to the extent so held, be deemed severed from the contract of sale between Purchaser and WhisperKOOL, and all of the other non-severed provisions will remain in full force and effect.
- D. Governing Law/Choice of Forum. The laws of the State of California (without regard for conflicts of law) shall govern the construction and enforcement of the these Terms and Conditions of Sale (Sections 1 through 9 inclusive, including Product Limited Warranty And Product Installation Requirements), and further these Terms and Conditions of Sale shall be interpreted as through drafted jointly by WhisperKOOL and Purchaser. Any dispute will be resolved by the courts in and for the County of San Joaquin, State of California, and all parties, WhisperKOOL, Purchaser and End User, hereby irrevocably submit to the personal jurisdiction of such courts for that purpose. No waiver by WhisperKOOL of any breach or default of the contract of sale (including these Terms and Conditions of Sale) concerning a Product will be deemed to be a waiver of any preceding or subsequent breach or default.
- E. Correction of Errors and Inaccuracies. These Terms and Conditions may contain typographical errors or other errors or inaccuracies. WhisperKOOL reserves the right to correct any errors, inaccuracies or omissions, and to change or update these Terms and Conditions, at any time without prior notice.

9. Questions, Additional Information And Technical Assistance

- A. Questions. If you have any questions regarding these Terms and Conditions or wish to obtain additional information, contact us via phone at 1-800-343-9463 or please send a letter via U.S. Mail to:

Customer Service
WhisperKOOL Corporation
1738 E Alpine Ave
Stockton, CA 95205

- B. Technical Assistance. WhisperKOOL Customer Service is available Monday through Friday from 6:00 a.m. to 4:00 p.m. PST. The Customer Service representative will be able to assist you with your questions and warranty information more effectively if you provide them with the following:
 - 1. The model and serial number of your WhisperKOOL UNIT.
 - 2. The location of the system and installation details, such as ventilation, construction of your wine cellar, and room size.

Model _____ **Serial Number** ____ _

Installed by _____ **Date** _____

*Whisper***KOOL™**

WhisperKOOL
1738 E. Alpine Ave
Stockton, CA 95205
1-800-343-9463